

**SİPARİŞ KODLARI / ORDERING CODES**

03	PC70	N1	P	A1	A8xAzB	D1	T1	G	KZ1
Sürgü sayısı Number of spools	Dilimli kumanda kolları Sectional control valve	Giriş kapağı tipi Type of the inlet cover	Yağ dağıtım yolları Way of distribution of oil	1. sürgü dağıtım tipi First distribution type	2. sürgü dağıtım tipi Second spool distribution type	3. sürgü dağıtım tipi Third spool distribution type	Çıkış kapağı tipi Type of the outlet cover	Dış ölçüleri Threads (P, A, B, T, N)	Genel kullanım şekli General operation feature

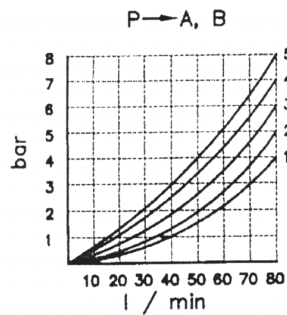
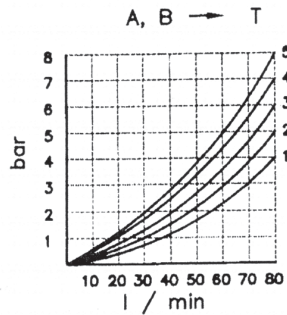
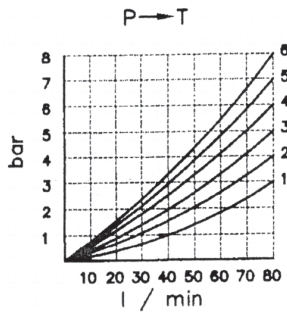
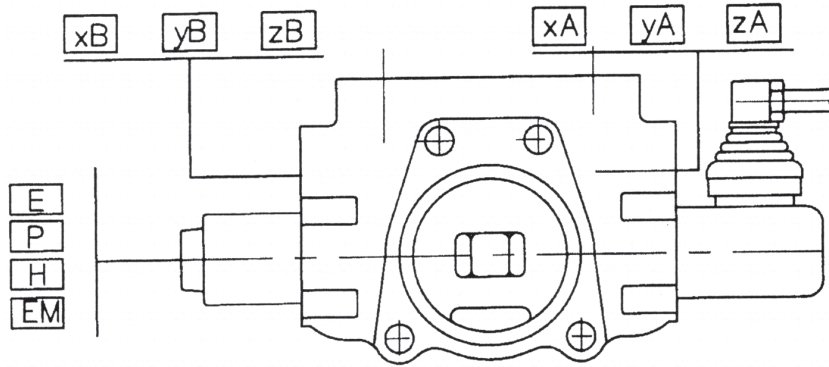

code kod	spool type / sürgü tipi
A	
B	
C	
D	
E	
F	
G	
H	
L	

code kod	spool control / sürgü kontrolü
1	
2	
3	
4	
5	
6	
7	
8	
9	
10	
11	
12	
13	

code kod	threaded connections dişli bağlantılar	code kod	way of distribution of oil yağ dağıtım yolları
	P, A, B      T, N	P	parallel
M	M22x1.5      M26x1.5	T	tandem(series parallel) / seri paralel
G	1/2"      3/4"	S	series

code kod	with electric switch / elektrik swiçi
E	 Mikroswitch Omron - V 165 I C5

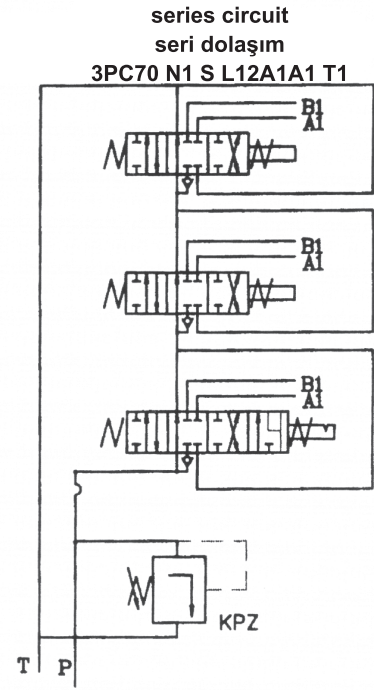
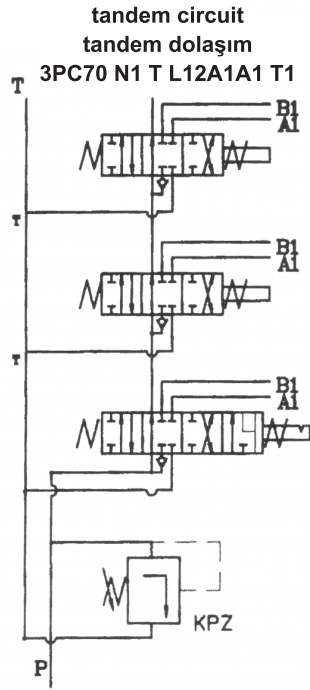
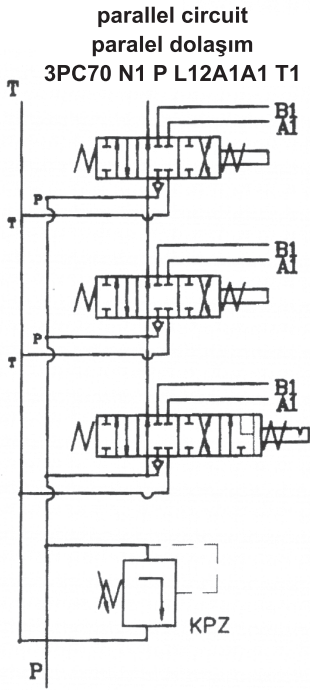

code kod	operation feature / operasyon özelliği
P	 pneumatic/pnömatik - pn = 6 bar/kalıp
H	 hydraulic/hidrolik - pn = 6 - 20 bar/kalıp

xA	xB	anti cavitation valve for A and / or B antikavitasyon valf A yada B
yA	yB	sek. pressure relief valve for A and / or B basınç boşaltma valfi A yada B
zA	zB	şok absorbe eden valfi A yada B shock absorber valve for A and / or B

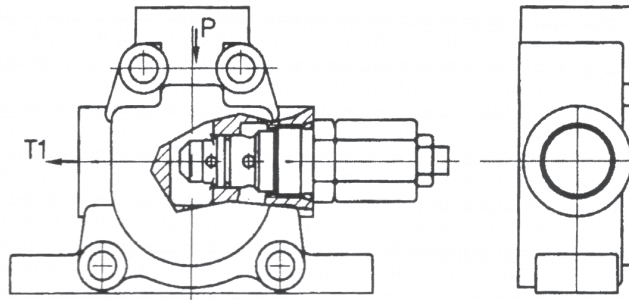

Inlet cover  
Giriş kapağı

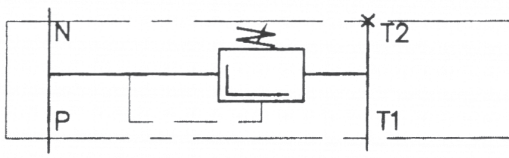
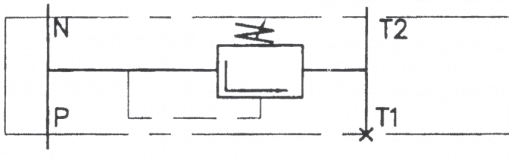

code kod	Inlet cover / Giriş kapağı
N1	
N2	
N3	

genel kullanım şekli / general operation feature

Anticavitation Valve(X)  
Antikavitasyon Valfi(X)

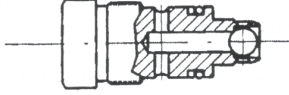



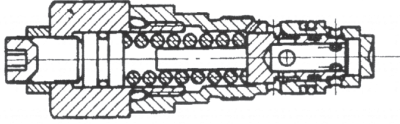

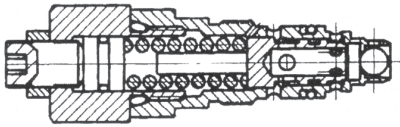

Second relief valve(Y)  
İkinci Emniyet valfi(Y)

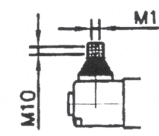
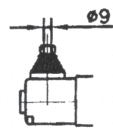
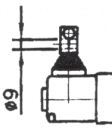
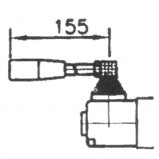
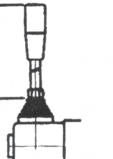
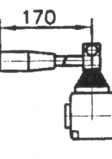

Relief and anticavitation valve (Z)  
Emniyet ve Antikavitasyon Valve (Z)

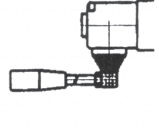

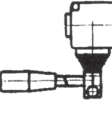
code kod	feature / özellik	code kod	feature / özellik	code kod	feature / özellik
KZ		KY		KI	
KZ1		KY1		KI1	
KZO		KYO		KIO	
KZ01		KY01		KI01	
-	without lever system / Lever sistemsiz				

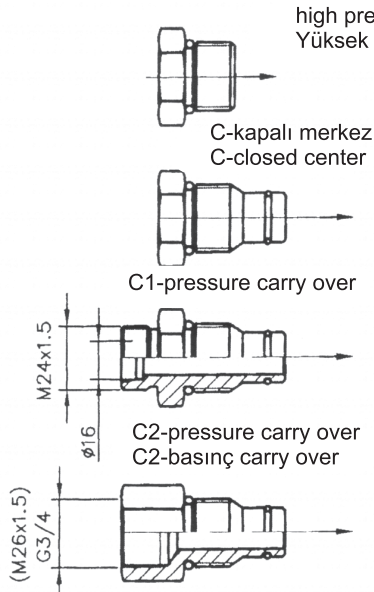

high pressure carry over  
Yüksek basınçlı seri bağlantı

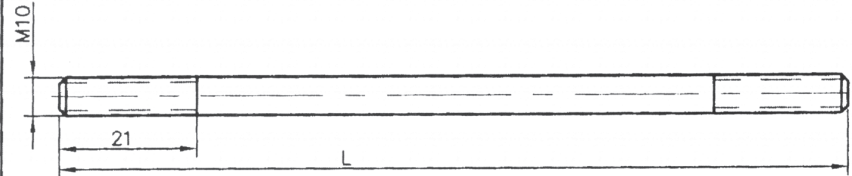
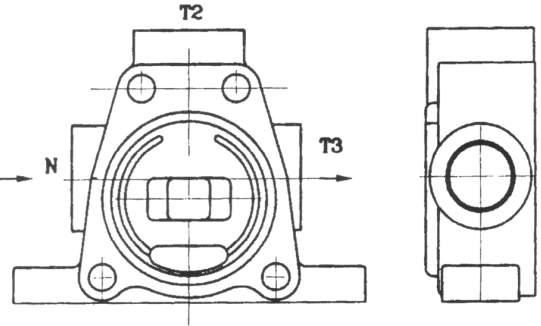

Number of Spool Sürgü Sayısı	1	2	3	4	5	6	7	8
L	139	182	225	258	311	354	397	440